

# Wireless electro-installation

Home & building wireless solutions



# ELKO EP, Holding



We are traditional, innovative and purely Czech development manufacturer of electronic devices and we have been your partner in the field of electroinstallations for 26 years.

ELKO EP employs about 330 people, exports its products to more than seventy countries, and has representatives in thirteen foreign branches. Company of the Year of the Zlín Region, Visionary of the Year, Global Exporter of the Year, Participation in the Czech TOP 100, these are just some of the awards received. Still, we are not finished. We are constantly striving to move forward in the field of innovation and development. That's our primary concern.

Millions of relays, thousands of satisfied customers, hundreds of our own employees, twenty six years of research, development and production, thirteen foreign branches, one company. ELKO EP, innovative- a purely Czech company based in Holešov, where development, production, logistics, service and support go hand in hand. We primarily focus on developing and manufacturing systems for building automation in the residential, commercial and industrial sector, a wide range of Smart city facilities and the so-called Internet of Things (IoT).



# Facts and stats

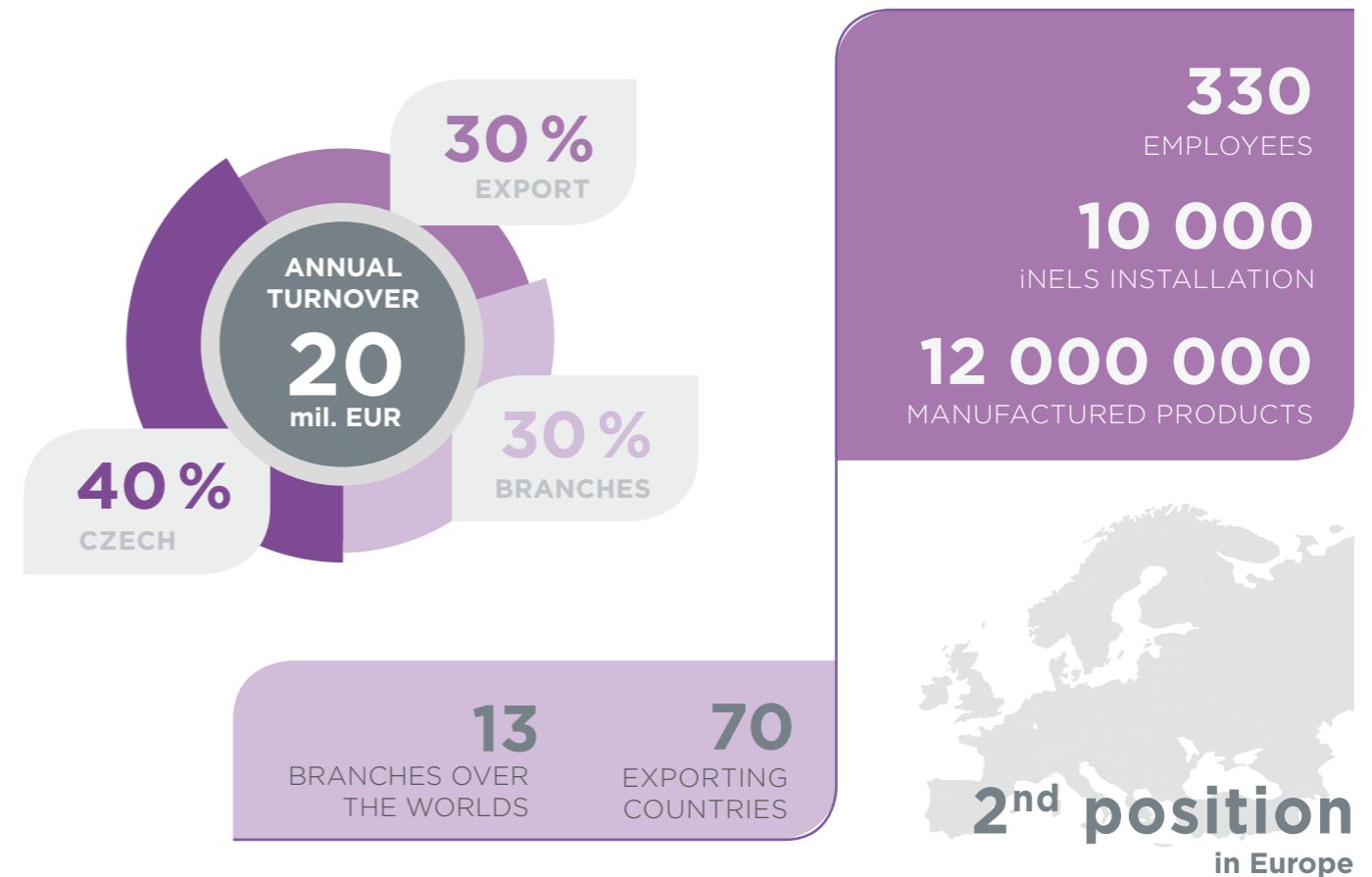

## WE ARE



### DEVELOPERS

In the new R&D center, more than 30 engineers develop new products and extend the functionality of existing products

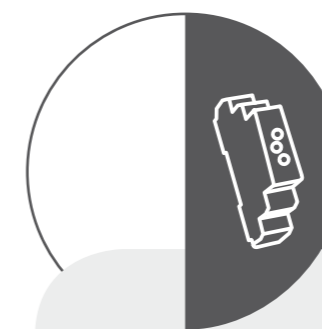

### PRODUCERS

modern antistatic spaces, 2x fully automated SMD production lines, 2 shift operations.



### SUPPORT

24 hours / 7 days / 360 days we not only provide technical support but also logistics.

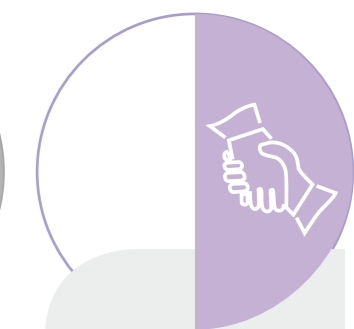

### SELLERS

personal access to more than 70 sales representatives in ELKO EP Holding provides impeccable services and superior products at an affordable price.

# Why a Smart Home?

**A Smart Home is not a necessity of life, but is becoming a vital requirement. It can do what a classic electrical installation cannot, or can only do with great difficulty.**

Each potential customer has different motivations for wanting to set up a smart home. Some are interested in savings, others like combining comfort with safety, but in either case, all the characteristics are an inseparable part of the system, and it is only up to the customer which ones are most important.

The main advantage of iNELS RF is it performs wirelessly. This means that you do not need to carry out extensive alterations to your electrical installations to promote them to a higher order of magnitude.

So you can indulge what was not possible before. In addition, the electronic installation can be extended, changed or upgraded at any time.



## Savings

- by efficient heating or AC regulation, you can attain savings of up to 30 %
- dimming lets you save around 15 %
- further savings: linking appliances, time switching, weekly mode, detectors

## Safety

- the system includes detectors of motion, smoke and open windows
- you can create an alarm to protect your property and loved ones

## Comfort

- you can control comfortably from a controller in the pocket or smartphone
- by pressing a single button, you perform several commands at once
- you need not worry about switching things off - they switch automatically or based on fulfilling a condition

## Monitoring

- integrated video cameras provide a view of what is happening at a location you are currently away from
- events are recorded onto a log that you can view later
- you can connect from anywhere in the world and monitor your home in real time or from the recording

## Automation

- everything is set up to function automatically
- weekly heating mode, blinds at dawn, lights at dusk
- the motion detector is not only for security, but detects the presence of persons for other functions as well

## Flexibility

- option of adding more devices
- change in functions by simple readjustment
- settings and management remotely without needing to arrive on site

# You can control your devices in various ways

**It does not matter what you control, but how easily you control it. With us you can control the devices and appliances in many ways, one at a time or combine them at will.**

For those conservatives amongst us, there are buttons in the form of switches exactly as we know and are used to them, for those of us who often move around the house in the garden, the RF Pilot remote control in your pocket will surely be appreciated. Touch unit is again designed for those who like everything in one place with a - 3.5 "display securely holding all the necessary buttons within the frame. An interesting and often preferred option is the driver's smartphone - which most of us already have in our pocket.

You can control iNELS with:

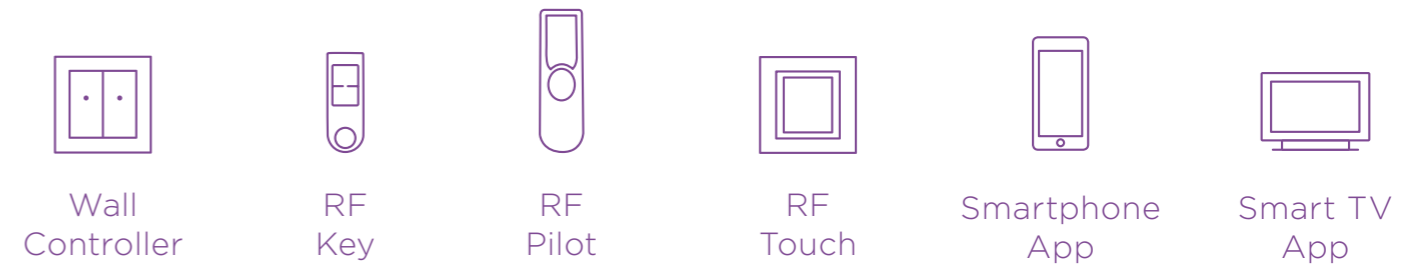

## Wireless wall controller

- wireless and in premium design
- the high variability of wireless switches
- simple installation - can be attached or fixed anywhere
- it also offers control of up to any 4 lights



## 4 button controller - keychain

- pocket controller for every day
- small dimensions make it possible to have the key fob always handy
- it can control up to 4 independent devices and switch scenes



## Wireless remote controller with display

- here marks the start of home automation
- the remote controller with OLED colour display offers control of up to 40 household appliances
- lights, sockets, garage doors, sprinklers, blinds, awnings, etc.



## Wireless touch unit RF Touch

- design element with a touch of luxury fittingly accenting any interior
- it will become a central, wireless intuitively controlled home
- coloured 3.5" TFT display



## Smartphone

- the only controller that comes free
- one of the main thoughts behind the iNELS is to keep one's home under control
- after downloading the application, you can control the entire house

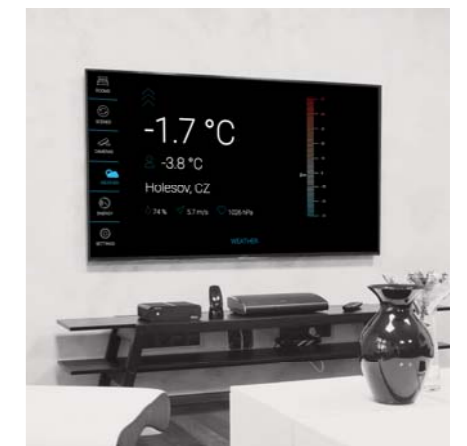

## Smart TV

**TIZEN**

- by Samsung Smart TV from model 2013 iNELS RF via Smart RF Box
- you can add to the app a floorplan of your room and house for easier control
- installing and using the app iNELS Home control from Samsung sites is free

# Your home

**The wireless iNELS RF system offers you a unique chance to breathe life into your home.**

Controlling appliances, dimming lights, creating light scenes, security - we need all these functions in our daily lives. iNELS RF is a building kit that you build just the way you like. The result will be one system that takes complete care of the running of your home. It will become an indispensable part of your family. You can fully adjust iNELS based on what you do or where you are, whether on vacation or at work, with family at home or with friends, or whether you are waking up or going to sleep.



### APPS for your home

Through an application on your smartphone, you can control your home while keeping complete track of all its ongoing processes.





# Living room

**This is the room where not only family, but friends and guests meet. It is usually the home's largest room, and all technologies and multiple lights are installed here. You also may spend the majority of your time here.**

With the press of a single button, iNELS lets you set up a light scene to suit the current situation or mood. The control touch unit puts the entire home virtually under your thumb - switch off all the lights, close the gate, read the outside temperature and set the thermostat in the children's room.



**Wireless touch unit  
RF Touch**

Wireless touch unit for central control of your home wireless system. Besides switching and dimming, it provides a current overview of energy consumption and is a part of the home intercom. The color 4" TFT display enables quick and easy control of appliances

# Kitchen

**The kitchen is a room with a large number of appliances. These include the stove, the dishwasher, the hood and the refrigerator. It is therefore natural to protect this area. This is accomplished either by a surge monitor in the distribution box or by detectors.**

The smoke detector monitors a sudden fire or flare-up. The flame detector is the foundation of safety in your home. Battery power makes installation easy. The integrated temperature sensor scans for the critical temperature at which materials not producing smoke can ignite. The unique, stylish design is appropriate in every modern interior.



## **Smoke detector**

This detector helps protect persons and property from a fire that has ignited. After detection, it immediately sends this information to your smartphone. The warning can be in the form of notification in the application. It also triggers an audible alarm.





# Bedroom



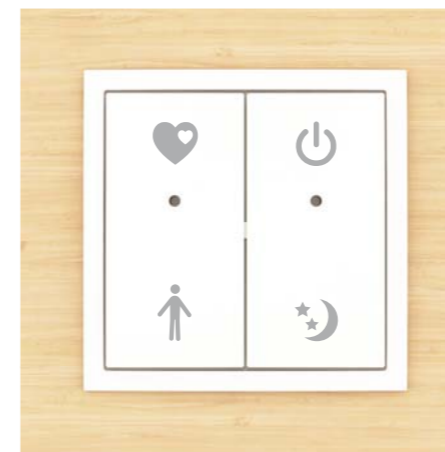

## You control the lighting and blinds with a switch on the nightstand.

With a long press, you set the brightness to your desired intensity, and keep one button reserved to light the way to the bathroom at night. With one practical button, you can also switch off all lights, even the forgotten ones (master switch).

The color LED lamp or colour LED strip will provide a wonderful bedroom atmosphere to suit your mood.



### Button for "GOOD NIGHT"

-  • set romantic light scenes
-  • master switch (All OFF)
-  • night light corridor to toilet
-  • gradual dimming off



# Children's room

**Ideal when they're playing, being good and safe. The wireless button grows with the children.**

For the older and more resourceful kids, the RF Pilot is ready. It can not only play with the colours of the coloured LED lamps and strips, but can also control everything else in your home.

In the meantime, a video camera is monitoring the toddler in the crib and a night light chases away bad dreams – a lamp set by a dimmer to minimum brightness.



Camera Preview



Wireless remote controller with display / 4 button controller - keychain



# One system, one application for whole house

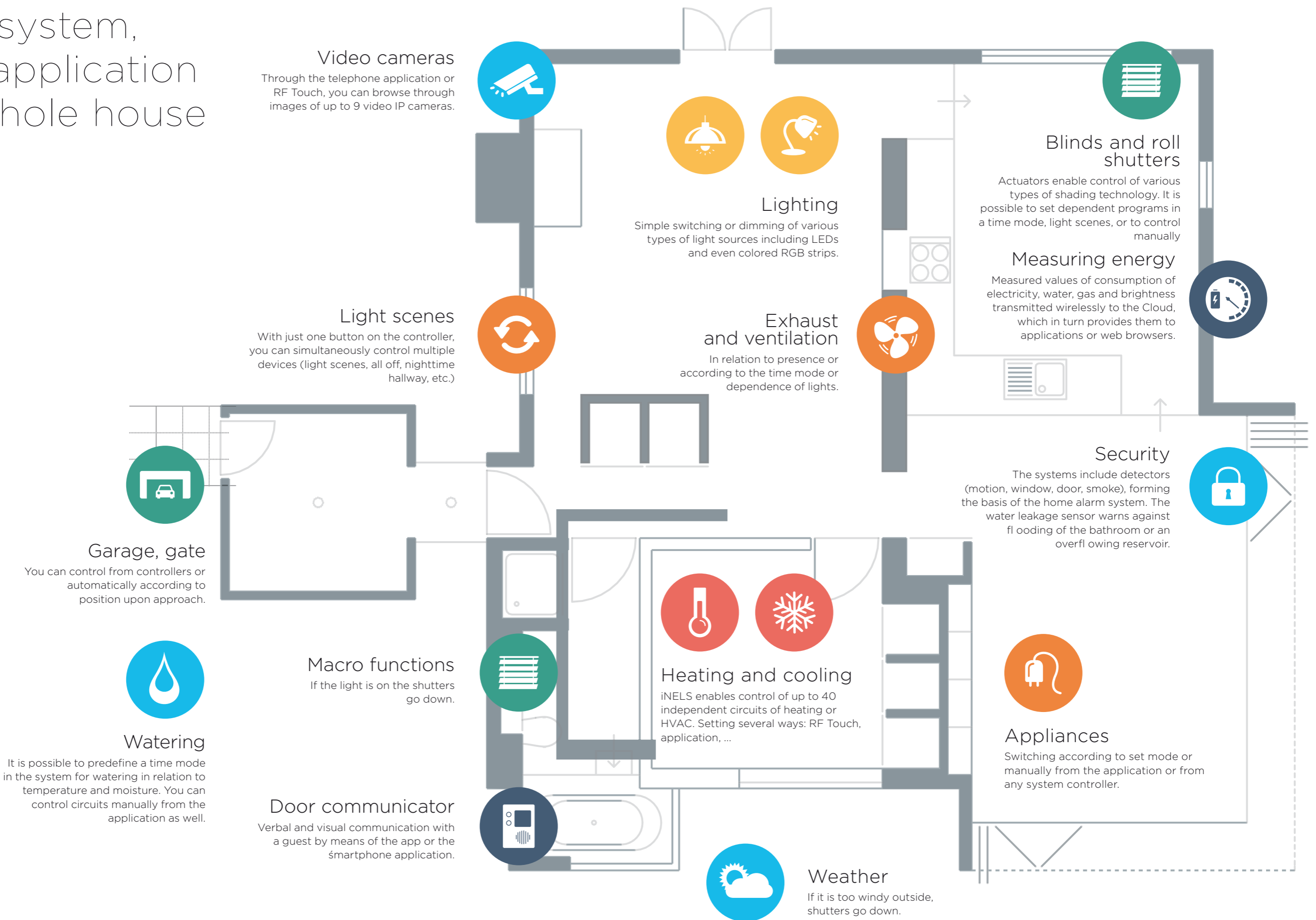

# Temperature regulation

**Heat regulation - with RF Touch, you have heating under control throughout the home.**

It is not necessary to have a thermostat in each room, and yet you can regulate each room separately. Whether you are controlling a radiator-mounted thermovalve or floor-mounted electrical cable, this element always has a temperature sensor that sends information to RF Touch, which then regulates the home based on the set temperature and according to a time program.



## Wireless touch unit RF Touch

- this is a touch wireless unit with a 3.5" display
- can control up to 40 heating or AC circuits = 40 thermostats in 1 device
- in connection with other wireless units, it can react to an open window or outdoor light intensity
- if the thermostat is connected to the Internet, it sends temperature information via the Cloud, and you can set the temperature from anywhere using a mobile application





## Wireless temperature controller

RFTC-50/G

- used for autonomous temperature control for underfloor pipes and auxiliary heating
- the display features information on the current and set temperature and heating parameters
- weekly program

# Heating, ventilation & air-conditioning

**The iNELS can control various heating sources - water, gas and oil boilers and regulate radiators, spiral heaters, fan coil units or electrical cables.**

Using a wireless sensor, it can sense not only the outdoor, but also the indoor or floor temperature. Control is possible from RF Touch, a mobile application or by Temperature controller.



## Switch unit with a temperature sensor

RFSTI-11B

- the ideal solution for underfloor electrical (hot water) heating, where the external sensor senses the floor temperature, and a unit directly switches the heating mat (cables)
- the automatic program with manual regulation is performed via the unit RF Touch or the application iNELS Home Control



TC sensor

## Wireless temperature sensor

RFTI-10B

- measures the indoor (internal) and outdoor (external) temperature
- it sends the measured temperature to RF Touch or to a Smart RF Box
- temperature range -20 to 50 °C (-4 to 122 °F)
- battery power allows placement anywhere, sensors from TC/TZ line



## Wireless thermo-valve

RFATV-1

- measures the ambient temperature that it then compares with the set temperature in RF Touch or in the App
- based on regulation, it controls water valves in radiators and heating ladder
- temperature range 0–32 °C (32–90 °F)

# Shading controls, door, gates, jalousies, blinds, roll shutters...

**Controlling garage doors, entrance gates, barriers, blinds, roll shutters, wnings - all of these can be controlled from a single controller - either a key alarm, RF Pilot or smartphone app.**

The main advantage of integration with the iNELS system is the option of presetting light scenes. In practice, this could mean closing the blinds at a set time or pulling down roll shutters in the event of bad weather - automatically, based on information from the weather station or manually. Whether you're at home or away. Another advantage to controlling light scenes is grouping multiple blinds together and controlling them with a single button or a single command. The pinnacle of use is rotating the lamellas of the blinds based on outdoor light intensity or sunset/sunrise. Yes, iNELS can do this too.



Blinds/Shutters

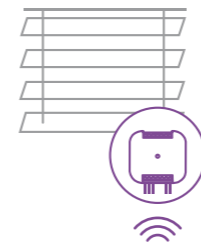

Awning

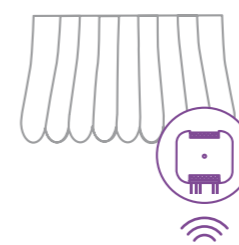

Access gateway



Garage

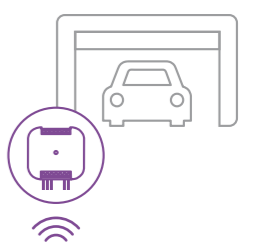

## Switch unit for shutters

RFJA-12B

- the shutters unit is used to control garage doors, gates, blinds, awnings, etc.
- load up to 2 x 8 A
- integrated time-functions



4 button controller - keychain

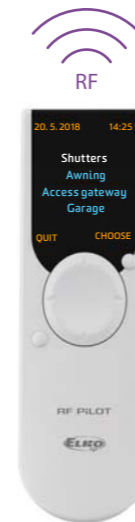

Wireless remote controller with display

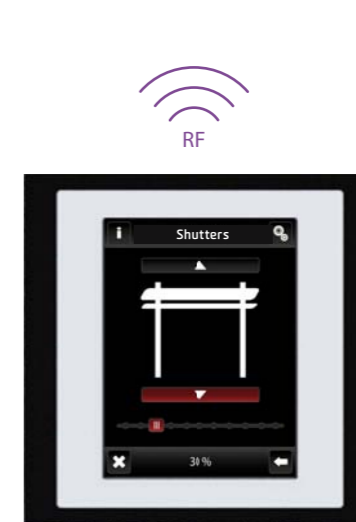

Wireless touch unit RF Touch



App

# Intercom & Video door-phone

**Intercom function allows communication between RF Touch units or intercom calls between these units and smartphones or tablets.**

You can also receive audio/video transmission from the front door communicator through the intercom and you can see and speak with visitors even if you are not at home. It is a comfortable replacement of traditional doorbells or door phones. It is a wireless installation allowing a user to open the door or gate.



## Door Communicator

- enables communication with voice- and video equipment in the facility: LARA, phone applications, tablet or TV - where individual devices can be combined
- videophone basic module can be extended with additional modules (for residential houses or buildings).
- the only connection required is a LAN cable that also supplies power (PoE)

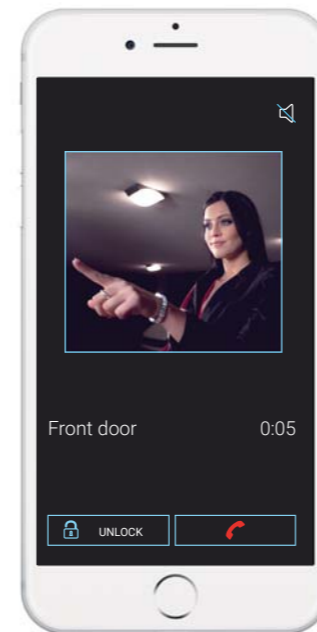

iNELS enables you to redirect a door bell ringing and consequent video conversation to your phone, even if you are not at home.

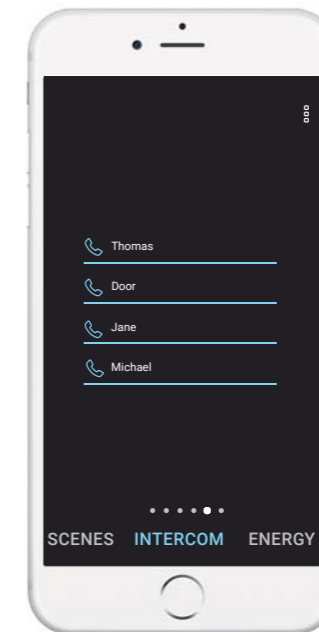

The application enables calls between participants on smartphones, tablets, or LARA device.

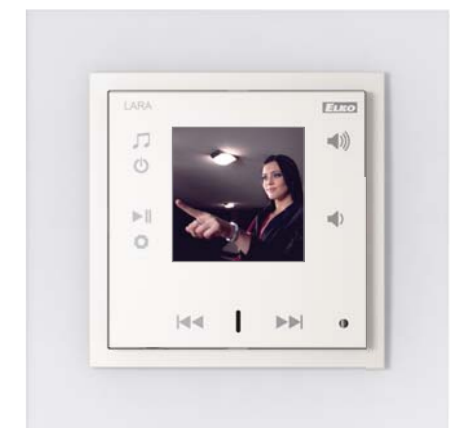

Besides playing your music or the radio, the LARA unit can also facilitate a video conversation with the door communicator, the home intercom system or calls to the application in your mobile phone.

# Intercom & Door-phone

iNELS enables communication inside the home (Intercom) as well as calls from the Video door-phone. There can be up to 30 users on various devices: LARA, Smartphone, Tablet, TV. Thanks to having its own server, it is possible to communicate (for free) even if you are away from home - a simple Internet connection suffices. A call at the door can also be forwarded.

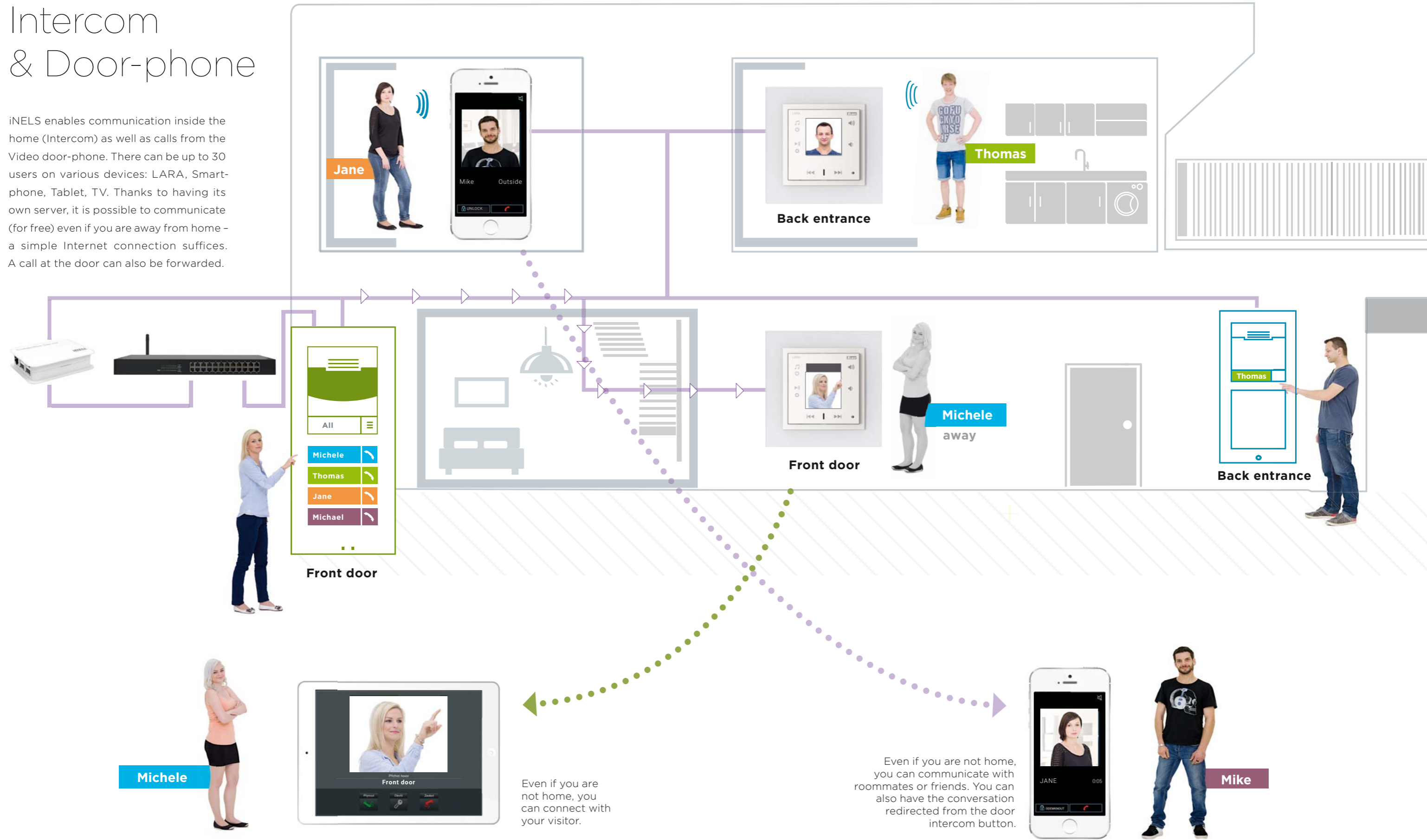

Even if you are not home, you can connect with your visitor.

Even if you are not home, you can communicate with roommates or friends. You can also have the conversation redirected from the door intercom button.



Smoke detector

RFSD-100

- it detects smoke from a fire
- automatic testing
- integrated temperature sensor
- battery status indicator
- battery power



Motion detector

RFMD-100

- it detects movement of persons and automatically controls lighting
- infrared scanning method to prevent false alarms
- battery power



Window / Door detector

RFWD-100

- it informs you as you are leaving that a window or door is open
- upon activation, it sends information to the unit or Application
- integrated temperature sensor
- battery power

## Security & Safety

**Security of residents and protection of property are top priorities. For this reason, iNELS provides detectors that sense smoke, motion or open windows or doors.**

Thanks to iNELS, you can set up basic security for your home, which, if breached, sends a notification in the application or via SMS. The flood sensor detects and indicates leaking water or an overflowing washing machine; after assessing the problem, you can thaw out a frozen gutter or remove icicles. You can connect some video cameras in the application that monitor internal or exterior movement.

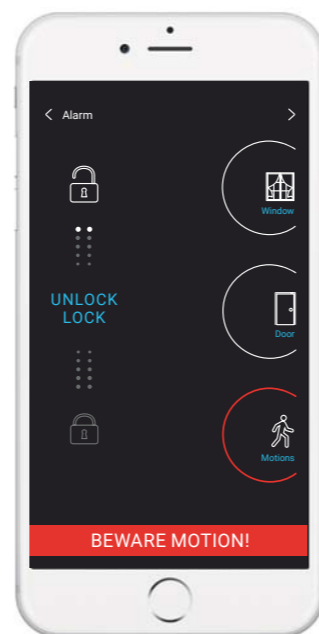

Wireless flood detector

RFSF-1B + FP-1

- it detects flooding or overflowing by means of an external probe FP-1
- when activated, it sends a signal to the app or RF Touch to the switching units for closing the water pipe



iNELS Cam

iNELS Cam

- up to 10 video cameras can be connected in the Application
- LAN or Wi-Fi connection
- 640 x 480 px resolution
- night IR illumination
- power adapter: 5V/1A (part of supply)



Video cameras

- you can connect any video camera supporting MJPEG2
- in the application, you can zoom in, zoom out and rotate if the video camera allows it



# Energy management

**Due to ever-rising energy costs, monitoring energy consumption is one of the most important aspects of a smart home.**

Wireless sensors are installed directly to the water meter or gas meter and by means of a concentrator at the electric meter, and information is sent to the Cloud for further processing. Data may be browsed through various filters in the Apps or Web browser.

It is also possible to set up notifications when critical parameter settings are exceeded and to switch on/off a certain device. Connecting to Smart Grid intelligent networks enables efficient electricity usage at optimal times.



## Energy gateway

RFPM-2M

- the energy gateway is a central device for assessing energy consumption (electricity, water, gas)
- it acts as an interface between the pulse converter RFTM-1 and your smartphone
- connection to the data network is made by means of a LAN Ethernet connector or wirelessly via a Wi-Fi network
- monitored data is stored on internal memory storage
- by means of the application iHC and Cloud connection, it is possible to maintain online access to data and monitoring history
- up to 4 tariff meter readings of electricity consumption



## Current transformer

CT50

- opening pliers open/close on the existing wire of the measured circuit, most frequently at the main supply at the electricity meter
- it is connected to the energy gateway RFPM-2M (up to 3 CT)



## Wireless pulse converter

RFTM-1

- the wireless pulse transducer scans the sensor data from the meter and sends it to the RFPM-2M gateway for further evaluation
- supported sensors: LS (LED sensor), MS (magnetic sensor), IRS (IR sensor)



## Consumption overview

- all energy sources for the selected period
- comparison with previous period
- critical limits from previous values

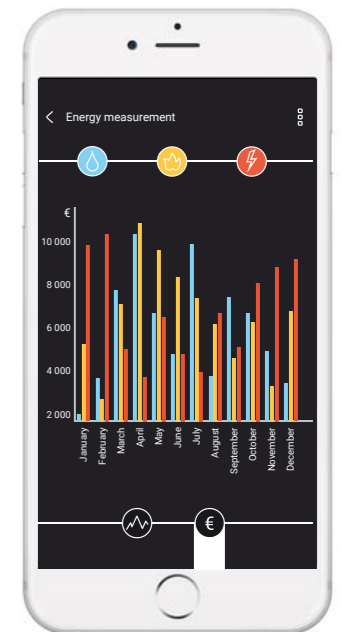

## History in a graph

- possible to display based on units or value
- time restriction: day, week, month or selected period

# Dimming & Lighting control

**Dimming is one of the basic characteristics of a smart home. Dimmers not only render a pleasant atmosphere, but also save on electricity.**

iNELS offers dimmers in various designs (box, flush, DIN rail mounted, socket) for all types of light sources including today's popular LEDs.

Colour strips and lamps have become a modern trend used not only for decorative illumination, but also more and more for lighting in the workplace. These too are integrated in iNELS.



RGB LED bulb

RF-RGB-LED-550

- receiver and dimmer enable setting of the brightness and colour
- luminance: 550 lm/675 lm, Base: E27
- lamp life: 30,000 hours
- function: brightness 0–100%, RGB lamp: automatic blending of colours

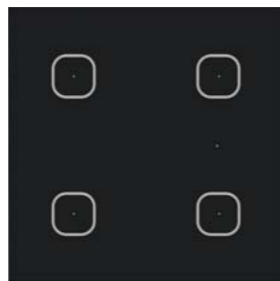

Wireless dimmer switch

RFDW-71

- wireless switch in glass design with integrated dimming element
- supply voltage: 230V AC/50 Hz, 120V AC/60 Hz
- 4-channel design
- control up to 25 channels
- 6 light functions



Wireless twilight switch

RFSOU-1

- the wireless twilight switch measures outside illumination intensity
- based on a set value, it controls the switching element
- elimination of short-term change of ambient lighting (glare)
- battery power



Dimming actuator for LED (RGB) strips

RFDA-73M/RGB

- dimmer for controlling 3 single-colour strips or an RGB colour strip
- control from the RF Key Alarm, RF Pilot, RF Touch or the Application
- inputs for controlling 0–10 V
- maximum load: 3x 5 A



Universal dimmer

RFDEL-71M

- designed for dimming various light sources 230 V (600 VA), 120 V (300 VA)
- type of load: R, L, C, ESL, LED
- smooth dimming or brightening
- setting min. brightness for eliminated flashing LED sources
- DIN rail mounted



Universal dimmer

RFDEL-71B

- designed for dimming various light sources 230 V (160 VA), 120 V (80 VA)
- type of load: R, L, C, ESL, LED
- smooth dimming or brightening
- setting min. brightness for eliminated flashing LED sources
- flush mounted

# Appliance control

**It is possible to switch a multitude of electrical devices and appliances.**

Whether they are connected to a socket, installation box or hard-wired, INELS has the right switch design for them.

Switching actuators are not only used for switching appliances but also allow you to set dependent functions - time-dependent or functions depending on the value of other input - motion detectors, flood sensors, light sensors or door opening detectors.



Switching socket

RFSC-61

- switched socket for controlling fans lamps, heaters and other devices connectible by cable with plug
- time-functions up to 10 hours



Wireless switch unit

RFSA-61M

- the switching unit is used for controlling appliances, sockets, lights or ventilation
- can be combined with detectors



Wireless switch unit

RFSA-66M

- the switching unit can switch up to 6 independent circuits (socket, light)
- integrated time-functions for each channel separately

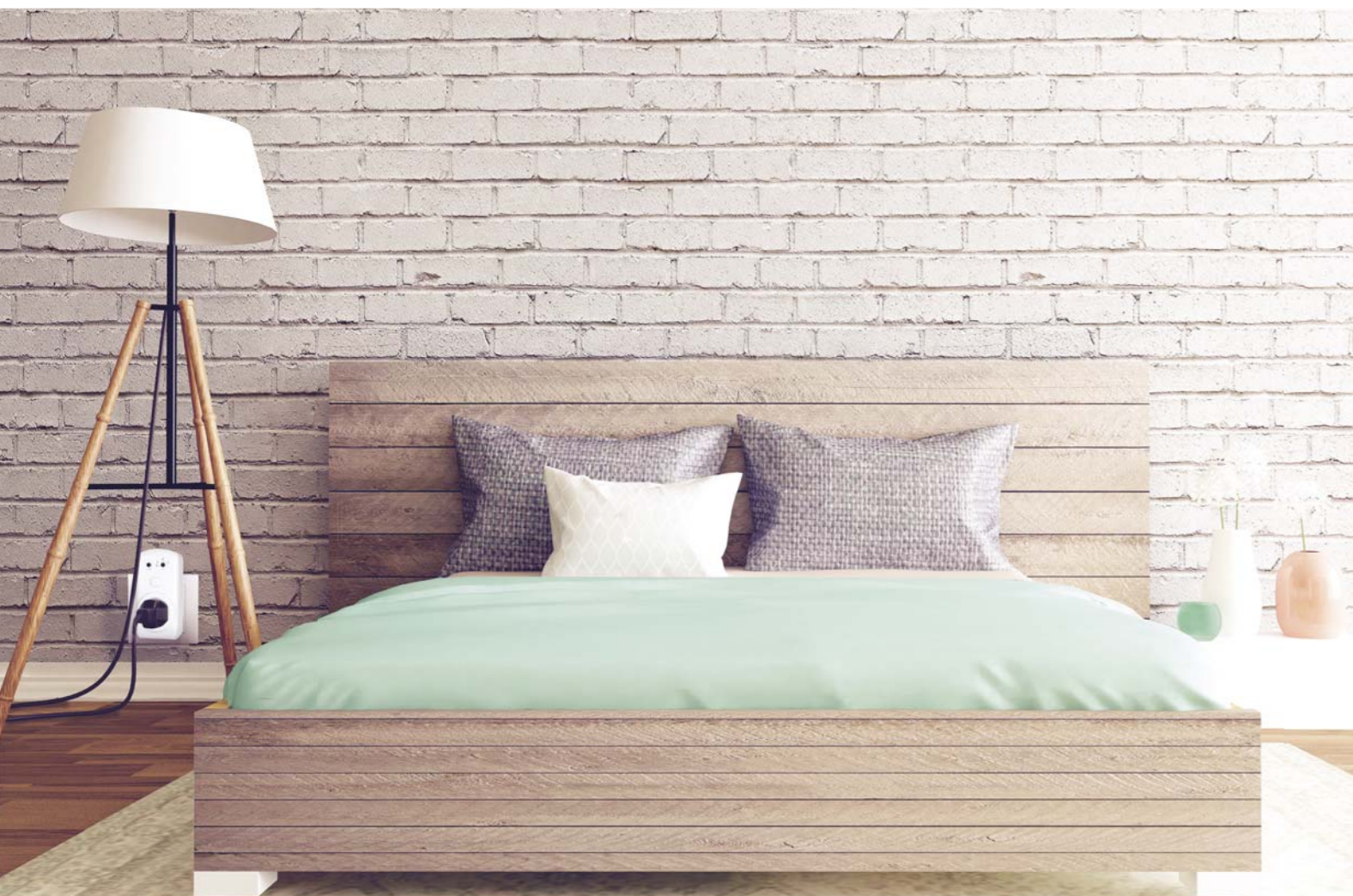

Wireless switch unit with the input

RFSAI-61B

- the switching unit with 1 output channel is used for controlling appliances and lights
- integrated time-functions up to 60 min.
- terminal for connection existing push button switch



Wireless switch unit

RFSA-62B

- the switching unit with 2 output channels is used for controlling appliances and light circuits
- integrated time-functions up to 60 min.

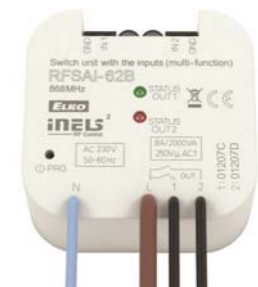

Dual Band wireless switching component input button

RFSAI-62B

- the switching unit with 2 output channels is used for controlling appliances and light circuits
- integrated time-functions up to 60 min.

# How you will control it?

**The system can be controlled in a wide variety of ways. These include buttons the size of a classic switch, which control four various devices or functions. A button can be attached, glued or simply placed somewhere.**

The wireless key alarm makes for a suitable pocket controller of gates, garage doors or entrance ways.

RF Pilot with its OLED color displays serves as a basis for home automation. It can control up to 40 devices, which can be located in individual rooms.



## DESIGN LOGUS<sup>90</sup>

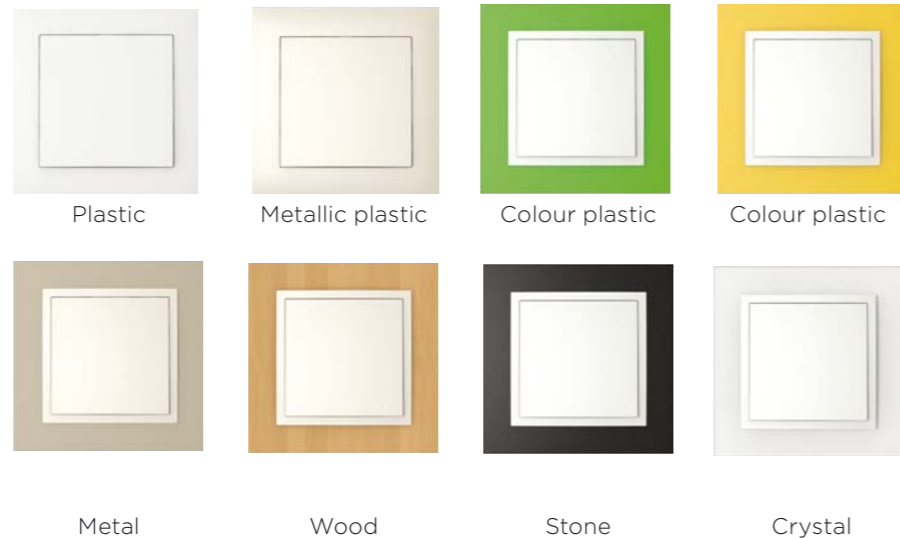

### Wireless wall controller

RFWB-20/G, RFWB-40/G

- controls 2/4 appliances independently
- light scenes function
- battery power
- design: plastic, glass, wood, metal, stone, ...
- flat base
- silent operation



### Wireless touch unit

RF Touch - W

- system unit, which controls your smart home
- controls up to 40 units
- thanks to bi-directional communication, it displays the status of appliances



### Wireless remote controller with display

RF Pilot

- controls up to 40 appliances independently
- scenes function
- integrated temperature sensor
- battery power
- coloured OLED display



### 4 button controller - keychain

RF Key

- controls 4 appliances independently
- light scenes function
- battery power
- design: white, black

# Behind the scenes

**Smart Boxes are important but invisible elements in the smart home system. They are used to interface with a controlling telephone through its application. They are connected to the network, and if remote control is necessary, also to the Internet.**

The Smart Box also acts as a mediator for storing data in the Cloud. Signal repeater – the repeater is used to extend the range where it is necessary to control devices over a greater distance.

New, now you can also use as signal repeaters other units in our portfolio, such as the switching, dimming components that use the protocol RFIO<sup>2</sup>.



## Smart RF Box with WiFi

eLAN-RF-Wi-003

- smart RF box is center of your Smart Home and bridge between your smartphone and controlled appliances
- thanks to the two-way communication, it visualizes the current status of individual units/actuators
- controls up to 40 units
- the intuitive app iNELS Home Control
- provides a centralized control from one place



# iNELS Wireless System

Outdoor PTZ camera



Wi-Fi

Weather station

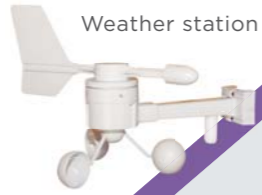

Indoor PTZ camera



Indoor camera

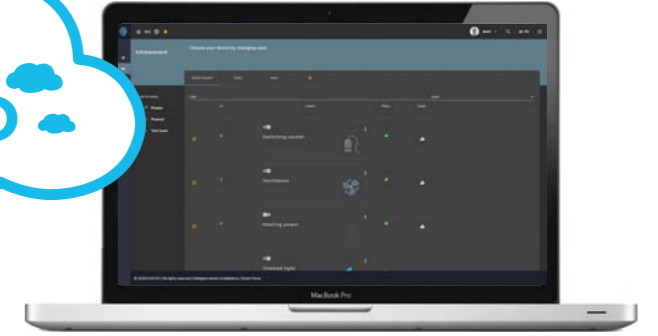

RF - radiofrequency protocol

Wi-Fi

Electricity panel meter

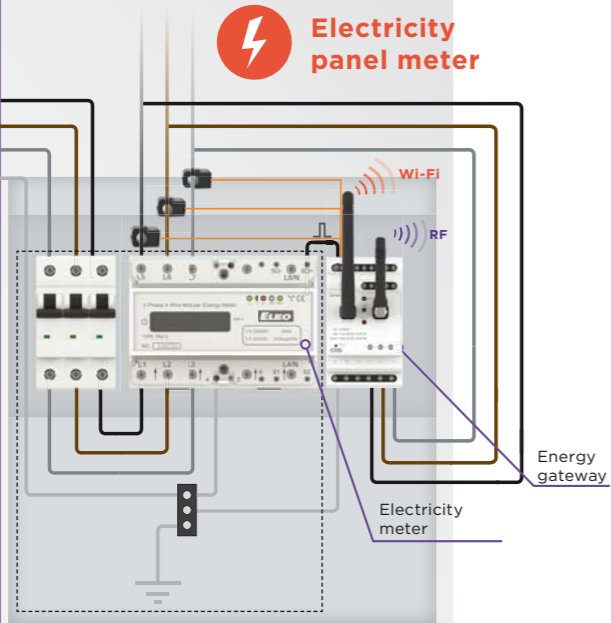

Wi-Fi Router



Smart IR Box

## Controllers:

Application for the smartphone



Radio and Intercom

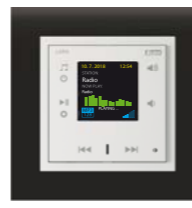

Wireless touch unit



Wireless wall controller



Wireless temperature controller



Wireless dimmer switch

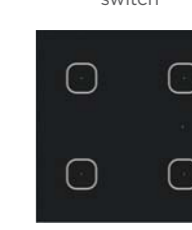

Wireless remote controller with display & 4 button controller - keychain



## Detectors:

Smoke

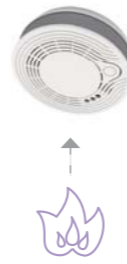

Window / Door

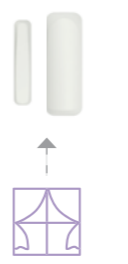

Motion



Wi-Fi



Smart RF Box Wi-Fi

## Sensors:

Flood



Temperature



Twilight



## Elements:

Wireless switch unit



Switching unit - 1 output



Switching socket



Switch unit for shutters



Wireless thermo-valve



Wireless switch unit



RGB Coloured LED bulb



Dimming actuator



Audio/ Video



Home appliances



L3  
L2  
L1  
PEN

Video door-phone



Water meter

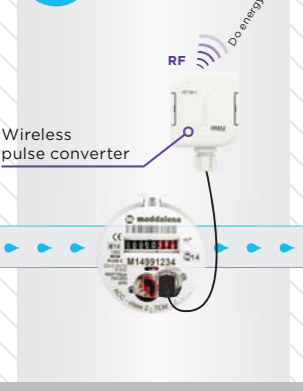

Gas meter

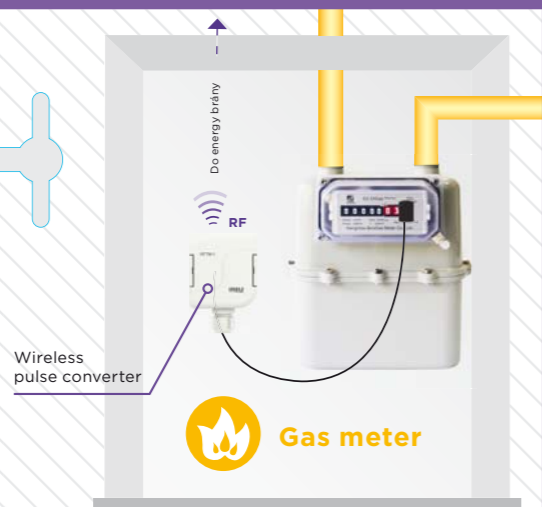

# Apps for all

**Applications that you can download completely free, with which you can control all devices connected to the system.**

On your device, you can view power consumption values and charts, check security cameras, or control your home audio. At the same time, you can configure all your devices through the application.

The application is designed for smart phones and watches running on Android or Apple iOS.

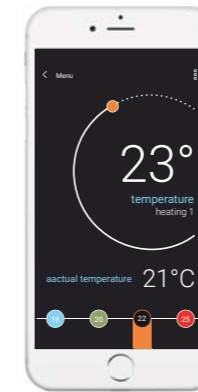

## Overview of functions

- Lighting control
- Blinds/Shutters
- Sockets
- Garage doors/gates
- RGB bulbs, LED strips
- Scenes
- Heating
- Cameras
- Air conditioning
- Weather station
- Energy control
- Video door-phone
- Audio/Video

	Available on the iPhone 	ANDROID APP ON 		

	✓	✓	✓	✓
	✓	✓	✓	✓
	✓	✓	✓	✓
	✓	✓	✓	✓
	✓	✓	✓	✓
	✓	✓	✓	✓
	✓	✓	✗	✗
	✓	✓	✓	✗
	✓	✓	✗	✗
	✓	✓	✗	✗
	✗	✓	✗	✗
	✓	✓	✗	✗
	✓	✓	✗	✗

### Overview

Absolute control over all appliances.

### Thermo

You can set the temperature in each room just the way you like.

### Lighting control

Dim up/down set romantic light scenes with RGB.

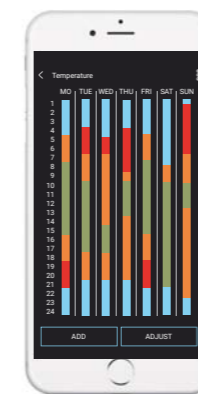

### Blinds control

Did you forget to set the shutters in light of the weather? No problem.

### Scheduling

When and what mode of heating in one place for a week-arranged and easier.

### Cameras

You can keep an eye on the security of your home from anywhere on earth.

# iNELS References

Since we began supplying iNELS, we have performed over 10,000 installations. Introducing a selection.

A fully remote-controlled squash center in Hungary, a French restaurant in Prague's Municipal House, a discotheque in Kiev, Ukraine, a summer residence on Mallorca and a myriad of apartments and houses. You can find our systems installed and implemented in hundreds of locations across the globe.

We can introduce the iNELS system to various projects, whether it concerns the residential sector or commercial space.

Quote can be found at:  
elkoep.inels.com

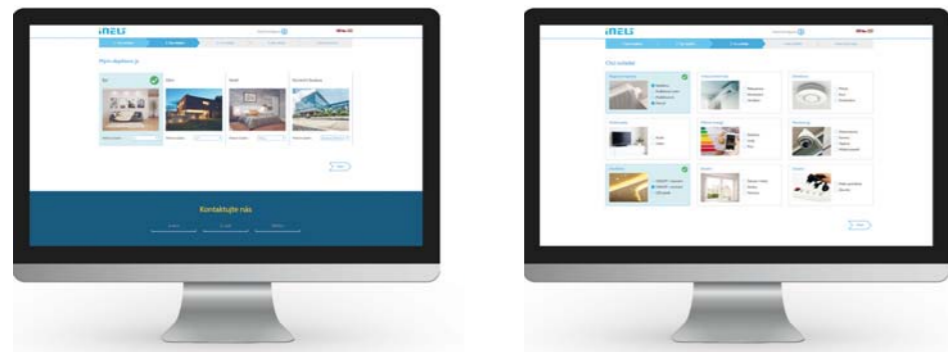

Smart Home & Building Solutions for



www.inels.com



Hotel Kempinski Bayterek

Almaty/Kazakhstan

- 5 star hotel
- lighting control in the public space
- more than 15 000 lights are controlled via DALI protocol
- lights scenes



Jamie's Italian

Budapest/Hungary

- iNELS BUS System is controlling lighting and terrace-cooling/heating
- high voltage neon signs, lighting control



Badorka Balaton Aquarium

Balatonfüred/Hungary

- iNELS controls all the lighting, for example the illumination of the aquariums
- speciality: there are no switches on the walls at all. Every light can be controlled via the 2 mounted tablets



Pest-Buda Bistro & Hotel

Budapest/Hungary

- the oldest hotel of Hungary, which was built in 1696
- 10 rooms with unique luxury equipment with heating & air-conditioning
- furniture & equipment has been renovated a few years ago



Villa

Beskydy/Poland

- iNELS bus system
- meteorostation
- lighting scenes
- using by tablet, smartphones and EST3



Hotel Wyndham

Istanbul/Turkey

- more than 3000 lighting circuits are controlled through the DALI protocol
- another thousand lighting circuits are controlled via DA3-22M units



## Thermo-regulation



Wireless touch unit  
RF Touch

- power: 100–230 V AC, from the side 12 V DC
- load: up to 40 units
- output: 2x potential free relays (3 A)

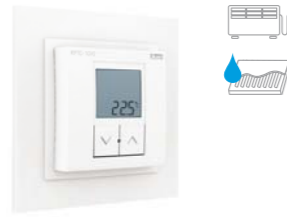

Simple wireless temperature controller  
RFTC-10/G

- power: 2x 1,5 V AAA battery
- temperature range: 0 to +55°C (32–131°F)
- integrated sensor
- design LOGUS<sup>90</sup> (glass, metal, wood, stone)



Wireless temperature controller  
RFTC-50/G

- power: 2x 1,5 V AAA battery
- temperature range: 0 to +55°C (32–131°F)
- weekly programming
- integrated sensor
- design LOGUS<sup>90</sup> (glass, metal, wood, stone)



Wireless temperature controller  
RFTC-100G

- power: 100–230 V AC/50–60 Hz
- temperature range: 0 to +55°C (32–131°F)
- weekly programming
- integrated sensor
- design LOGUS<sup>90</sup> (glass, metal, wood, stone)



Switching unit with a temperature sensor  
RFSTI-11/G

- power: 110–230 V AC/50–60 Hz
- temperature range: -20 to +50°C (-40–122°F)
- load: 8 A
- internal/external sensor
- design LOGUS<sup>90</sup>
- LED status indication



Wireless thermo-valve  
RFATV-1

- power: 2x 1,5 V batteries AA
- temperature range: 0 to 32°C (32–90°F)
- integrated sensor
- adapters: RAV, RA, RAVL



Wireless temperature sensor  
RFTI-10B

- power: 1x 3 V CR 2477 battery
- temperature range: -20 to +50°C (-40–122°F)
- internal/external sensor



Switching unit with a temperature sensor  
RFSTI-11B

- power: 230 V AC/50–60 Hz, 120 V AC/60 Hz, 12–24 V DC
- temperature range: -20 to +50°C (-40–122°F)
- load: 16 A

## Detectors



Smoke detector  
RFSD-101

- power: 4x 1,5 V AA battery
- smoke detection: optical light scattering
- autotest



Motion detector  
RFMD-100

- power: 2x 1,5 V AA battery
- detection angle 105°
- shot length 12 m (13.12 yd)



Window / Door detector  
RFWD-100

- power: 1x 3 V CR2032 battery
- opened window/door detection
- battery status indication



Wireless Flood detector  
RFSF-1B + FP-1

- power: 1x 3 V battery CR 2477
- terminal for external probe FP-1
- operation button: battery status, signal quality

## Cameras



IP camera  
iNELS Cam

- power: 5 V DC adapter
- resolution: 640 x 480 px
- night light
- up to 10 cameras in app



Video cameras

- you can connect any video camera supporting MJPEG2
- compatible cameras Axis, D-link, Dahua

## Energy management



Energy gateway  
RFPM-2M

- power: 230 V AC / 50–60Hz
- inputs: PULS1, PULS2, BUS
- tariff inputs: TARF1, TARF2
- current measurement probes 3 x CT50
- output RELAY: 1NO/NC, 16A
- connection: LAN/Wi-Fi



Wireless pulse converter  
RFTM-1

- power: 2x 1,5 V battery AAA
- supported sensors: LS (LED sensor), MS (magnetic sensor), IRS (Infra Red sensor)
- IP 65 protection

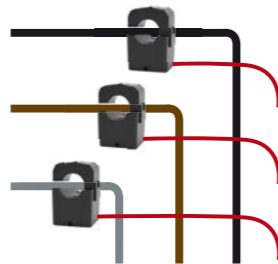

Current transformer  
CT50

- the opening CT are installed on the existing wire of the measured circuit, most frequently at the main input to the electricity meter
- current: 50 A
- frequency: 50/60 Hz
- dimensions: 31 x 46 x 32 mm (1.22 x 1.81 x 1.26 in)



Flashing LED

LED sensor  
LS

- the LED sensor scans LED pulses on meters, which indicate consumption by flashing
- cable length: 1.5 m (4.92 ft)



Built-in magnet in the gas meter

Magnetic sensor  
MS

- the magnetic sensor scans the pulse, created with every rotation of a magnet located on the unit dial
- cable length: 1.5 m (4.92 ft)



Rotating water meter indicator

Infra Red sensor  
IRS

- the Infra Red sensor scans the reflective curtain placed on the moving dial (mainly on water meters)
- cable length: 1.5 m (4.92 ft)



## Dimming actuators



Wireless coloured bulb

RF-RGB-LED-550

- power: 100–240 V AC 50/60 Hz
- luminous flux: 550 lm
- color temperature: RGB
- brightness regulation: 0–100%
- compatible base: E27
- durability: 30 000 h



Dimming socket

RFDSC-71

- power: 230–250 V/50–60 Hz (300 VA), 120 V AC/60 Hz (150 VA)
- type of load: R, L, C, LED, ESL
- light scenes functions
- minimum brightness setting
- operated from 32 channels



Dimming actuator

RFDA-73M/RGB

- power: 12–24 V DC stabilized
- load: 3x 5 A
- LED strips: single color 7,2 VA, 3x 8 m (3x 26.25 ft) RGB LED 14,2 VA, 10 m (32.80 ft)
- external control 0–10 V



Universal dimmer

RFDEL-71M

- power (Load): 230 V AC/50 Hz (600 VA), 120 V AC/60 Hz (300 VA)
- type of load: R, L, C, LED, ESL
- external control 0–10 V or potentiometer
- control from external button
- light scenes function
- minimum brightness setting
- operated from 32 channels



Universal dimmer

RFDEL-71B

- power (Load): 230 V AC/50 Hz (160 VA), 120 V AC/60 Hz (80 VA)
- type of load: R, L, C, LED, ESL
- control from external button
- light scenes function
- minimum brightness setting
- overheat protection
- operated from 25 channels



Wireless twilight switch

RFSOU-1

- power: 2x 1,5 battery AAA
- range: 1–100 000 lx
- twilight and light switch function
- time delayed setting (0–2 min.)
- IP65 protection

## Switching actuators



Switching socket

RFSC-61

- power: 230–250 V/50–60 Hz, 120 V AC/60 Hz
- load: 16 A
- time-functions (2 s.–60 min.)
- operated from 32 channels (of controllers)



Wireless switch unit

RFSA-61M

- power: 110–230 V AC/50–60 Hz, 12–24 V DC
- load: 16 A
- time-functions (2 s.–60 min.)
- operated from 25 channels (of controllers)
- option of connecting an external antenna



Wireless switch unit

RFSA-66M

- power: 110–230 V AC/50–60 Hz
- load: 6x 8 A
- 6 independent channels
- time-functions (2 s.–60 min.)
- operated from 25 channels (of controllers)
- option of connecting an external antenna



Switch unit for outdoor use

RFUS-61

- power: 230 V AC/50–60 Hz, 120 V AC/60 Hz, 12–24 V DC
- load: 12 A
- time-functions (2 s.–60 min.)
- operated from 25 channels (of controllers)
- IP65 protection



Wireless switch unit

RFSA-11B  
RFSA-61B

- power: 230 V AC/50–60 Hz, 120 V AC/60 Hz, 24 V DC
- load: 16 A
- single-function ON/OFF or multifunctional design
- operated from 25 channels (of controllers)
- manual control with inbuilt button



Wireless switching unit with the input

RFSAI-61B

- power: 230 V AC/50–60 Hz, 120 V AC/60 Hz, 24 V DC
- load: 16 A
- time-functions (2 s.–60 min.)
- operated from 25 channels (of controllers)
- terminal for control from existing button



Wireless switch unit

RFSA-62B

- power: 230 V AC/50–60 Hz, 120 V AC/60 Hz, 24 V DC
- load: 2x 8 A
- 2 independent channels
- time-functions (2 s.–60 min.)
- each channel can be controlled by up to 12 controllers



Dual Band wireless switching component input button

RFSAI-62B

- Supply voltage AC / DC 12 - 24, AC 120 V or AC 230 V.
- Load 2x 8A
- 2x independent channels
- 2x switching contacts (AgSnO<sub>2</sub>)
- time-functions (2 s - 60 min)
- each channel can be controlled by up to 12 controllers

## Controllers



Switch unit for shutters

RFJA-12B, RFJA-32B

- switching of roller shutters, blinds, awnings, garage doors, gates etc.
- possibility of connecting an existing buttons
- power: 230 V AC/50–60 Hz, 120 V AC/60 Hz, 12–24 V DC
- load: 2x 8 A
- operated from 25 channels (of controllers)



Wireless wall controller

RFWB-20/G, RFWB-40/G

- power: 3 V CR 2032 battery
- 2 channels /4 channels
- scenes function
- command LED indication
- switching with a micro-button



Wireless touch unit

RF Touch

- power: 100–230 V AC, from the side 12 V DC
- setting with up to 40 units + 30 detectors
- central unit with autocontrol
- status visualization
- coloured TFT LCD display, 3.5"



Wireless remote controller with display

RF Pilot

- power: 2x 1,5 V AAA batteries
- setting with up to 40 units
- inbuilt temperature sensor
- scene function
- status visualization
- colour OLED display



4 button controller - keychain

RF Key

- power: 3 V CR 2032 battery
- scenes function
- command LED indication

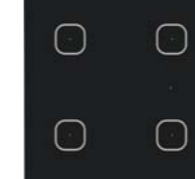

Wireless dimmer switch

RFDW-71

- wireless switch in glass design with integrated dimming element
- supply voltage: 230V AC/50 Hz, 120V AC/60 Hz
- 4-channel design
- control up to 25 channels
- 6 light functions



Wireless contact converter

RFSG-1M

- cheap/expensive current control
- power: 110–230 V AC/50–60 Hz, 24 V DC (galvanically separated)
- control input 12–230 V AC/DC
- option of connecting an external antenna



Wireless contact converter

RFIM-20B, RFIM-40B

- wireless contact converter changes your existing button to a wireless one
- power: 1x 3 V battery CR 2477 2x 3 V battery CR 2032
- 2 channels/4 channels

## Behind the scenes



### Smart RF Box

eLAN-RF-003

- power: 10–27 V DC/200 mA SELV
- setting with up to 40 units
- LAN connection
- automatic DHCP connection
- managing accounts/backup of projects via web interface

### Smart RF Box with WiFi

eLAN-RF-Wi-003

- power: 10–27 V DC/200 mA SELV
- setting with up to 40 units
- The HUB does not need Internet access for its operation; it creates its own Wi-Fi network
- managing accounts/backup of projects via web interface



### Wireless signal repeater to extend the RF signal range

RFRP-20

- power: 230–250 V/50–60 Hz, 120 V AC/60 Hz
- the socket function is retained

### Multifunctional GSM communicator

RFGSM-220M

- power: 11–30 V DC, backup power supply Li-Ion batteries
- inputs: 4 wire, 10 wireless RF
- outputs: 2 relay (2x 8 A), 10 wireless (RFS...)
- control via SMS or ringing
- control of up to 30 telephone numbers
- other functions: time delay, alarm, status report

## Door communicator



### Door communicator

BASE

- door communicator 2N Helios door entry system with camera for smaller installations with a built-in camera and one or two buttons
- you can choose from two variants of contactless RFID reader



### Door communicator

VERSO

- basic module series offers higher specification camera with IR illumination and night vision
- watchtower with multifunction modules can be changed according to customer needs
- you can choose mechanical illuminated keys, a numeric keypad or infopanel

## Accessories



### Thermodrive

Telva 230 V, Telva 24 V

- operating voltage: 230 V or 24V AC, 50/60 Hz
- stopping force: 100 N ±5%
- dimension h/w/l: 55+5 x 44 x 61 mm (2.17+0.2 x 1.73 x 2.40 in)



### Flood Probe

FP-1

- working temperature: -10–40°C (14–104°F)
- mounting: glue / screw
- length of cable: 3 m (3,3 yd)
- dimensions: 60 x 30 x 8 mm (2.4 x 1.2 x 0,3 in)



### Temperature sensors

TC

- range: 0–70 °C (32–158°F)
- sensor: NTC 12 K 5 %
- TC-0 - l. 110 mm (4.33 in)
- TC-3 - l. 3 m (1.42 yd)
- TC-6 - l. 6 m (1.75 yd)
- TC-12 - l. 12 m (13.12 yd)



### Temperature sensors

TZ

- range: -40–125 °C (-40–257°F)
- sensor: NTC 12 K 5 %
- TZ-0 - l. 110 mm (4.33 in)
- TZ-3 - l. 3 m (1.42 yd)
- TZ-6 - l. 6 m (1.75 yd)
- TZ-12 - l. 12 m (13.12 yd)



### Internal antenna

AN-I

- for GSM-220M, eLAN-RF-003, eLAN-RF-Wi-003, RFDA-73/RGB, RFSA-61M, RFSA-66M, EMDC-64M, RFDEL-71M and transmitter module RFSG-1M into plastic switchboard
- rod angle, without cable
- sensitivity 1dB



### External antenna

AN-E

- for RFGSM-220M, eLAN-RF-003, eLAN-RF-Wi-003, RFDA-73/RGB, RFSA-61M, RFSA-66M, EMDC-64M, RFDEL-71M and transmitter module RFSG-1M
- cable length 3 m (3.28 yd)
- sensitivity 5dB

# Protocol and compatibility

The communication between the components is wireless at 868–916 MHz (according to country standards/regulations), using the unique RFIO and RFIO<sup>2</sup> protocols. Both are proprietary wireless protocols from ELKO EP, which have a completely unique structure. RFIO<sup>2</sup> is an extension of the RFIO protocol and allows users to use newly introduced features, such as unit signals (repeater), for selected features. This protocol is fully compatible with the previous version of the protocol (RFIO).

### Available frequency for individual territories:

**866 MHz** India

**868 MHz** EU, Ukraine, Russia, Middle East

**916 MHz** South and North America, Australia,

New Zealand

### Benefits of RFIO:

- communication is low-energy and reliably transfers small data packets
- fees or licenses are not required
- no overlapping of communication space with unaddressed commands
- frequency used does not interfere with Wi-Fi/Bluetooth devices
- setting communication between components is not conditional on working with a computer or system

### Benefits of RFIO<sup>2</sup>:

- products labeled as "RFIO<sup>2</sup>" will allow newly set selected components such as unit signals (repeaters)
- for components, you can easily update FW using the RFAF/USB service device
- enables communication with RFMD-100, RFWD-100 and RFSM-100/RFSM-101
- data transfer between wireless components takes place in such a way that other receivers within range can help transfer the information (packet) to a remote receiver that is out of reach. It is possible to cover large-scale objects (real estate) and also increase the reliability of transmission in more demanding buildings
- backward compatibility with RFIO elements is retained

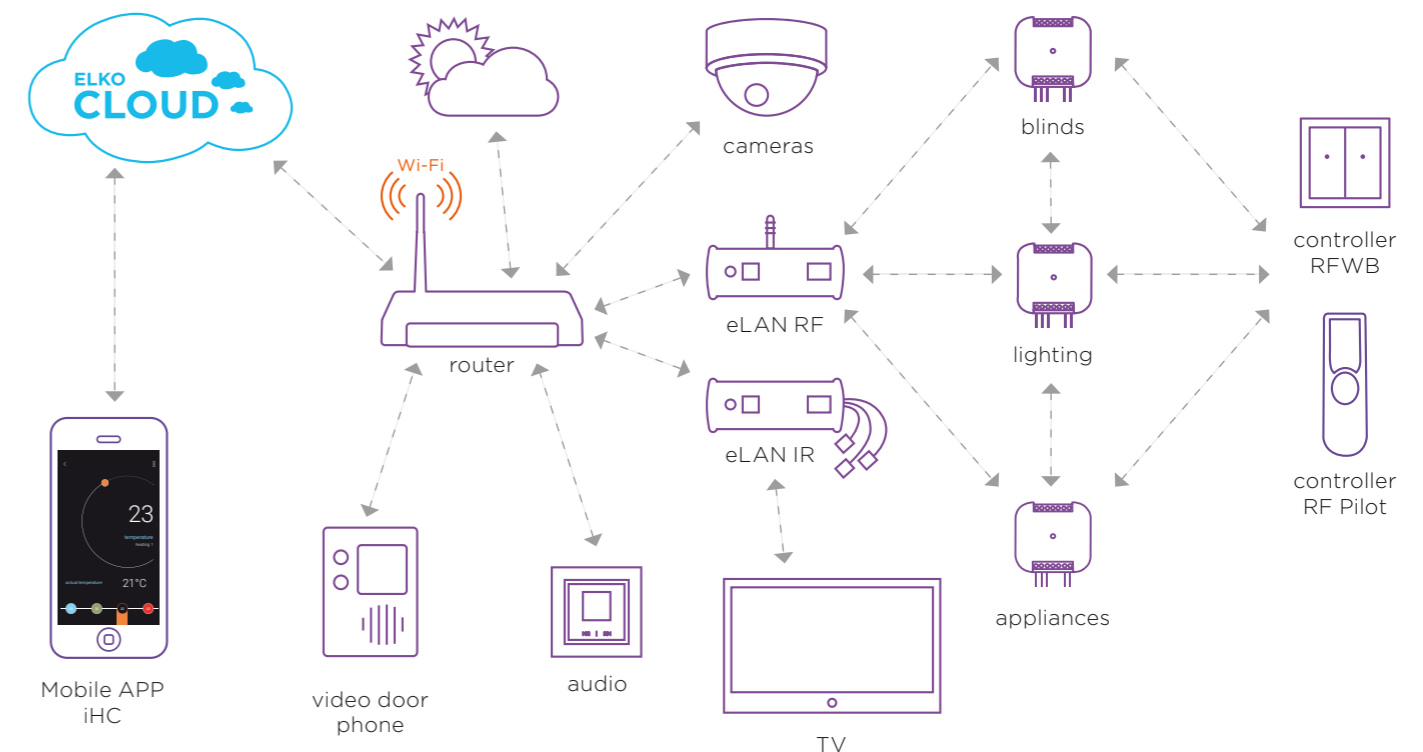

# Product dimensions

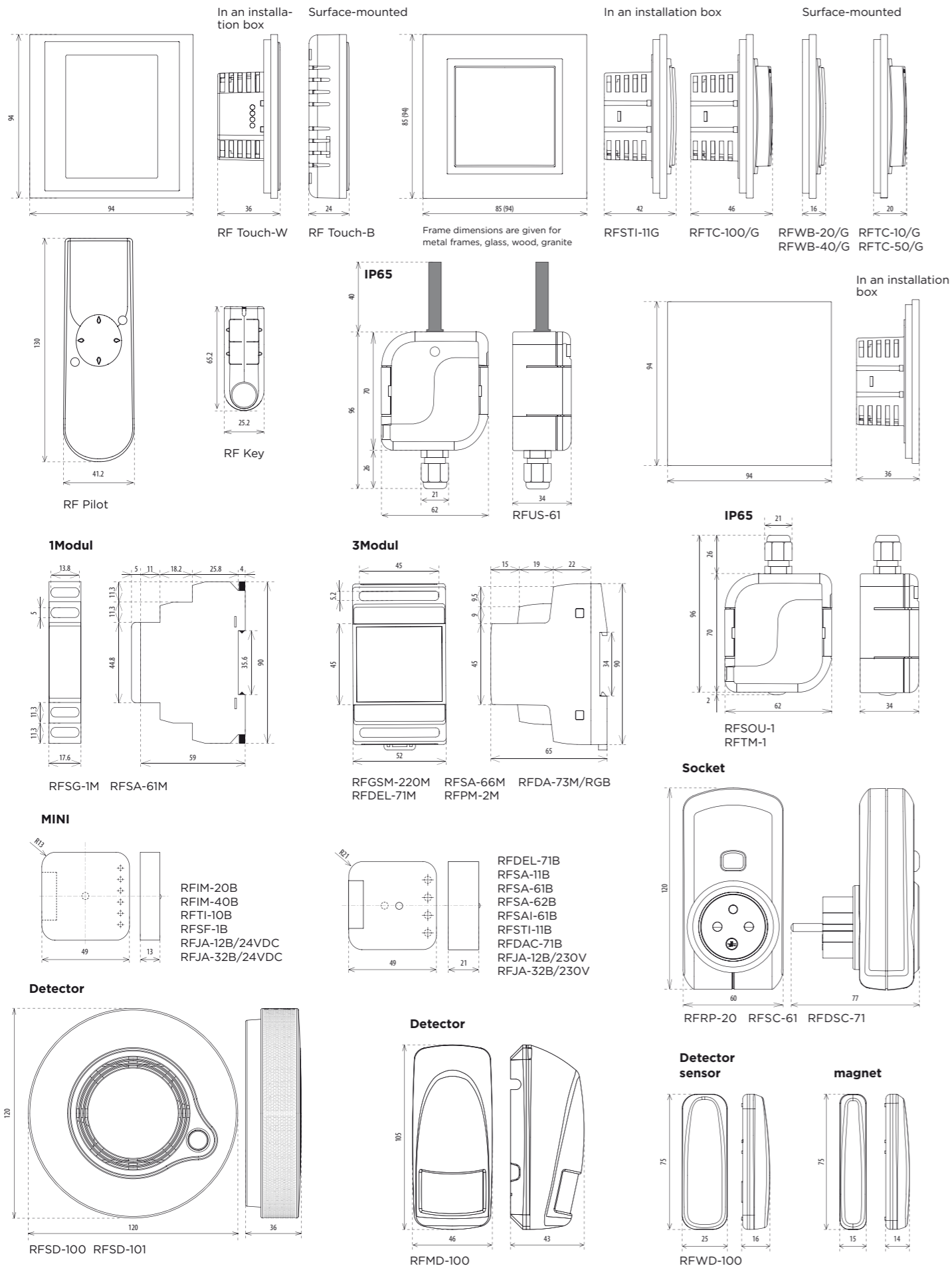

# Installation possibilities

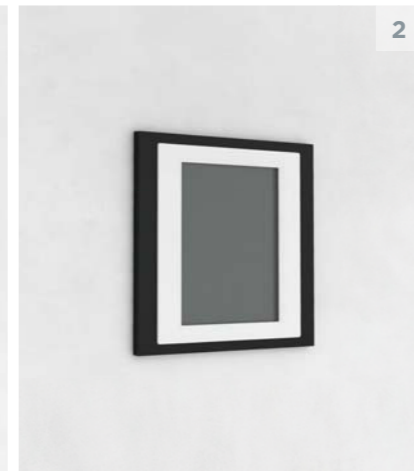

**1) Surface mounted**  
 Wall mounted or in an installation box with spacing of 65 mm.

RF Touch-W	RFTC-10/G
RFWB-20/G	RFTC-50/G
RFWB-40/G	RFTC-150/G

**2) Flush mounted**

RF Touch-B	RFTC-100/G
RFSTI-11/G	RFDW-71

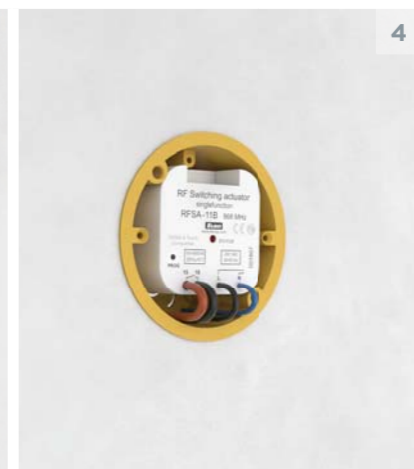

**3) DIN Rail mounted**  
 On DIN rail according to EN 60715.

RFSG-1M	RFDL-71M
RFGSM-220M	RFSA-61M
RFPM-2M	RFSA-66M
RFDA-73M/RGB	RFSA-166M

**4) Mounted to or in the installation box**

RFIM-20B	RFJA-12B
RFIM-40B	RFJA-32B
RFDAC-71B	RFSF-1B
RFDEL-71B	RFSTI-11B
RFSA-11B	RFTI-10B
RFSA-61B	RFSAI-161B
RFSA-62B	RFSTI-111B
RFSAI-61B	



**5) Mounted into the cover of appliance**

RFDAC-71B	RFSAI-61B
RFDEL-71B	RFJA-12B
RFSA-11B	RFJA-32B
RFSA-61B	RFSAI-161B
RFSA-62B	RFSTI-111B

**6) Surface mounted**

RFSOU-1	RFSD-100
RFUS-61	RFMD-100
RFTM-1	RFWD-100
RFSF-1B	

# ELKO EP Holding



[www.elkoep.com](http://www.elkoep.com)

Published: 01/2019 | 1st edition  
Modifications or amendments reserved.